

S6D06065L 650V SiC POWER SCHOTTKY RECTIFIER

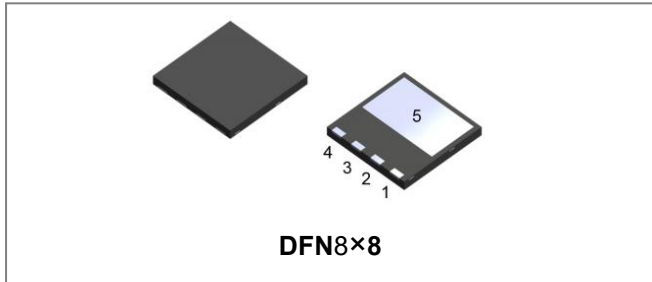

Description

S6D06065L is a SiC Schottky rectifier packaged in DFN8x8 case. The device is a high voltage Schottky rectifier that has very low total conduction losses and very stable switching characteristics over temperature extremes. The S6D06065L is ideal for energy sensitive, high frequency applications in challenging environments.

Circuit Diagram

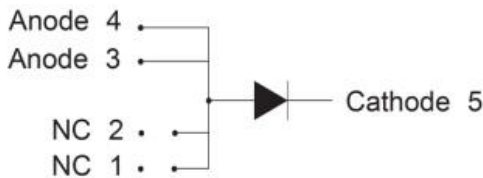

Features

- 175°C T_J operation
- Ultra-low switching loss
- Switching speeds independent of operating temperature
- Low total conduction losses
- High forward surge current capability
- High package isolation voltage
- Terminals finish: 100% Pure Tin
- “-A” is an AEC-Q101 qualified device
- Pb – Free Device
- All SMC parts are traceable to the wafer lot
- Additional electrical and life testing can be performed upon request

Applications

- Alternative energy inverters
- Power Factor Correction (PFC)
- Free-Wheeling diodes
- Switching supply output rectification
- Reverse polarity protection

Maximum Ratings

Characteristics	Symbol	Condition	Max.	Units
Peak Repetitive Reverse Voltage	V _{RRM}	-	650	V
Working Peak Reverse Voltage	V _{RWM}			
DC Blocking Voltage	V _{DC}			
Average Rectified Forward Current	I _{F(AV)1}	T _C =25°C	21	A
	I _{F(AV)2}	T _C =150°C	6	A
Peak One Cycle Non-Repetitive Surge Current	I _{FSM1}	10ms, Half Sine pulse, T _C =25°C	48	A
	I _{FSM2}	10ms, Half Sine pulse, T _C =110°C	42	A
Power Dissipation	P _{tot1}	T _C =25°C	62	W
	P _{tot1}	T _C =110°C	27	W

Electrical Characteristics:

Characteristics	Symbol	Condition	Typ.	Max.	Units
Forward Voltage Drop*	V _{F1}	@ 6A, Pulse, T _J = 25 °C	1.27	1.5	V
	V _{F2}	@ 6A, Pulse, T _J = 175 °C	1.40	1.6	V
Reverse Current*	I _{R1}	@V _R = rated V _R T _J = 25 °C	0.1	20	uA
	I _{R2}	@V _R = rated V _R T _J = 175 °C	2	200	uA
Junction Capacitance	C _T	V _R =0V, T _J =25°C, f=1MHz	580	-	pF
Reverse Recovery Charge	Q _c	I _F = 6A, di/dt = 200A/μs V _R = 400 V, T _J = 25°C	36.2	-	nC
Capacitance Stored Energy	E _c	V _R = 400 V	8.86	-	μJ

* Pulse width < 300 μs, duty cycle < 2%

Thermal-Mechanical Specifications:

Characteristics	Symbol	Condition	Specification	Units
Junction Temperature	T _J	-	-55 to +175	°C
Storage Temperature	T _{stg}	-	-55 to +175	°C
Typical Thermal Resistance Junction to Case	R _{θJC}	DC operation	2.4	°C/W

Marking Diagram

Where XXXXX is YYWWL

S6D = Device Type
L = Package type
06 = Forward Current (6A)
065 = Reverse Voltage (650V)
SSG = SSG
YY = Year
WW = Week
L = Lot Number

Cautions: Molding resin
Epoxy resin UL:94V-0

Ordering Information

Device	Package	Shipping
S6D06065L	DFN 8×8	3000/Reel
S6D06065LTR	DFN 8×8	3000/Reel

For information on tape and reel specifications, including part orientation and tape sizes, please refer to our tape and reel packaging

- China - Germany - Korea - Singapore - United States •
- <http://www.smc-diodes.com> - sales@smc-diodes.com •

Ratings and Characteristics Curves

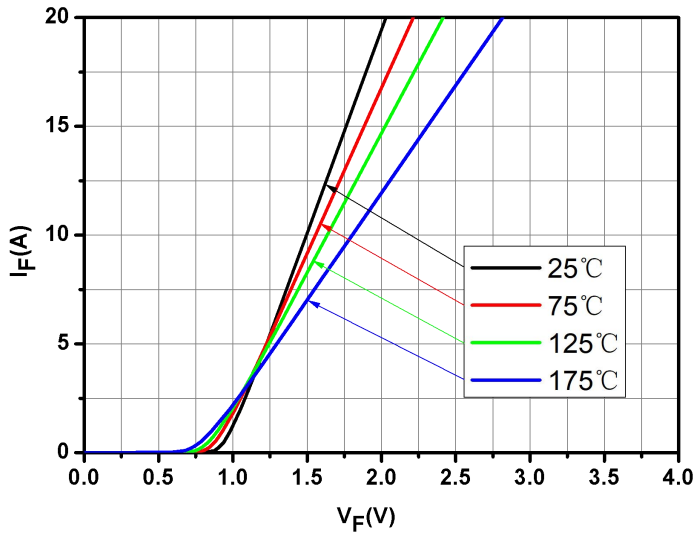

Fig.1-Typical Forward Voltage Characteristics

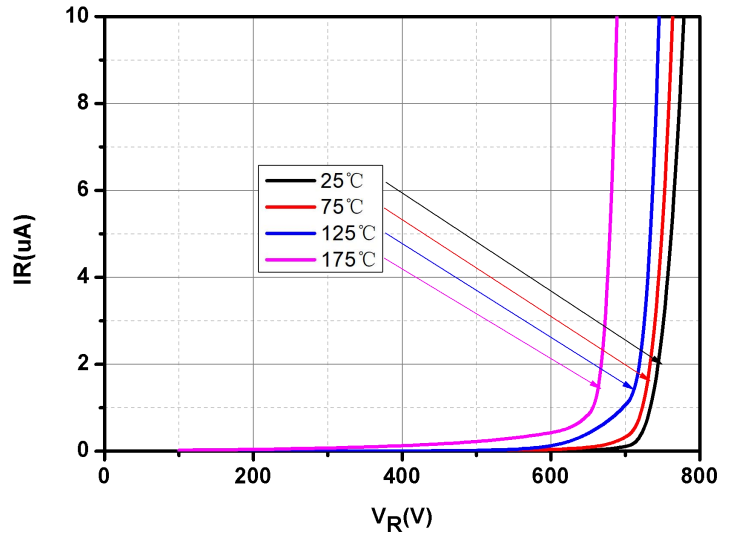

Fig.2-Typical Reverse Characteristics

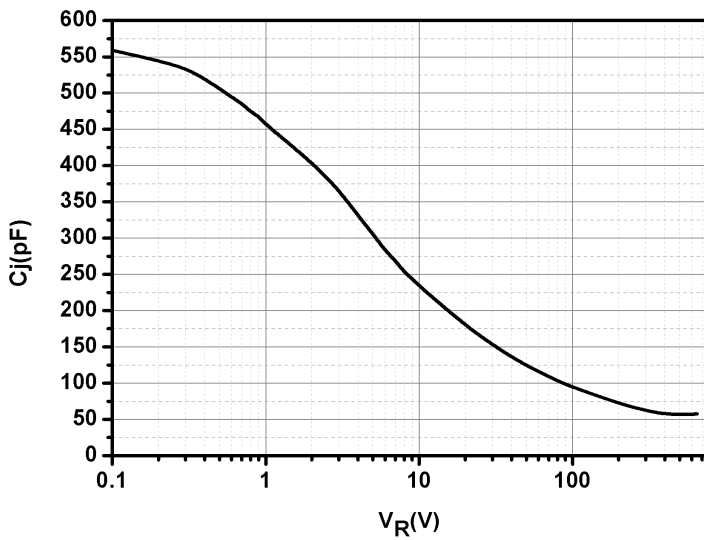

Fig.3-Capacitance vs. Reverse Voltage

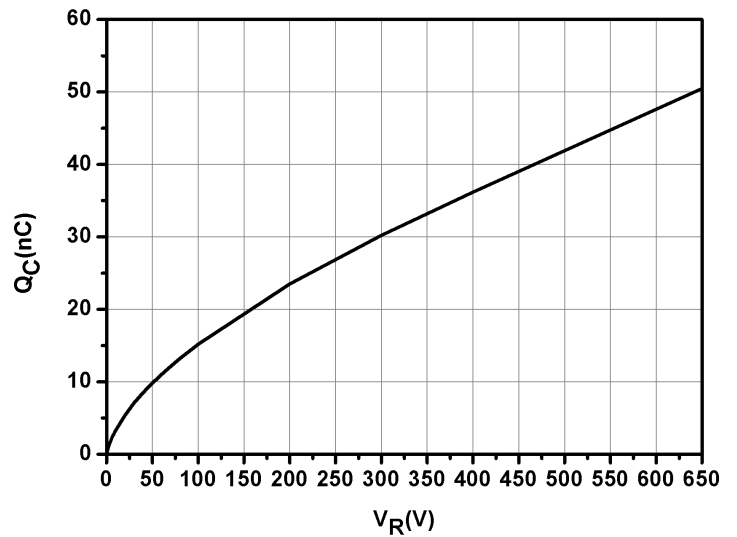

Fig.4-Total Capacitance Charge vs. Reverse Voltage

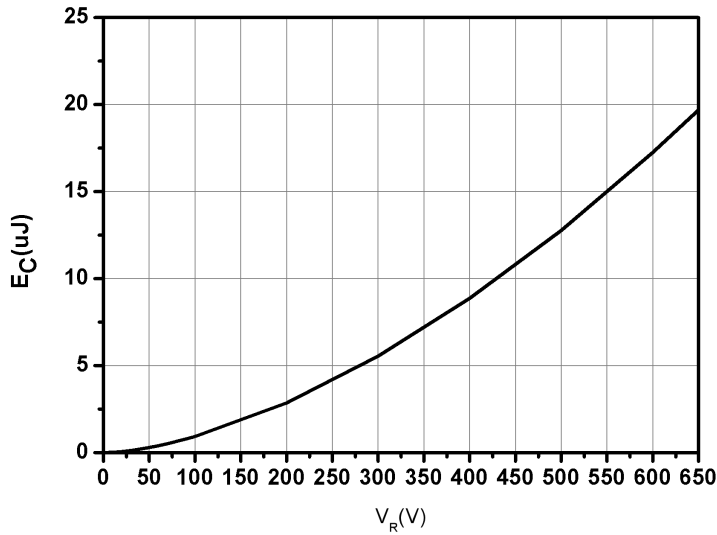

Fig.5-Capacitance Stored Energy

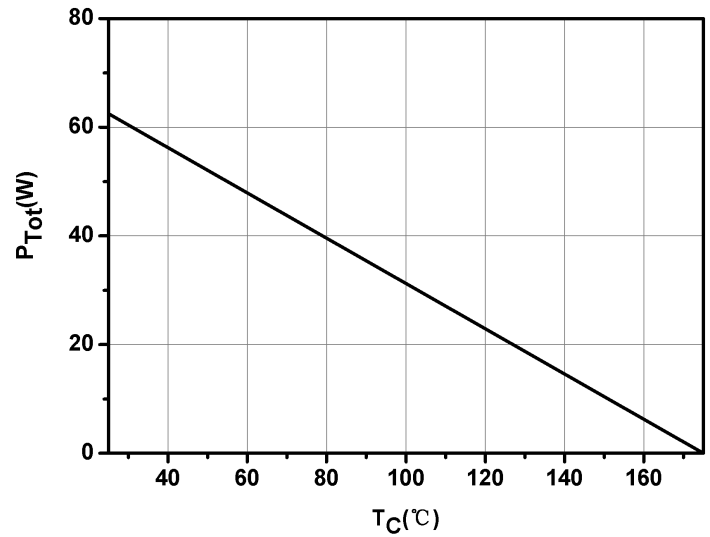

Fig.6-Power Derating

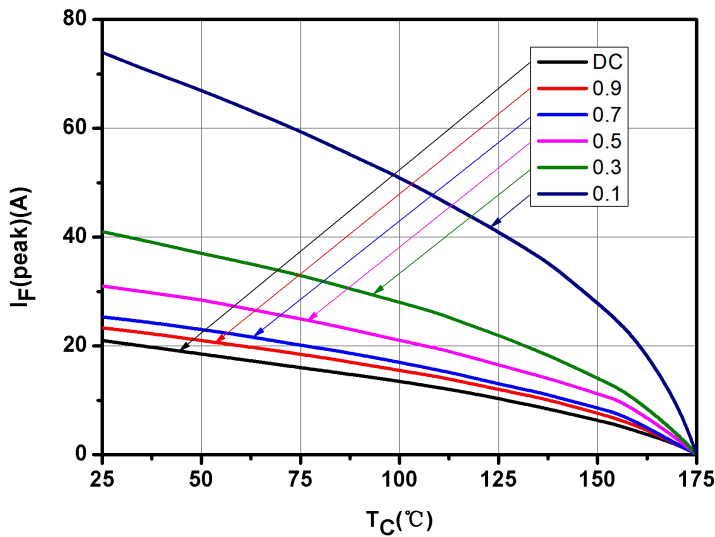
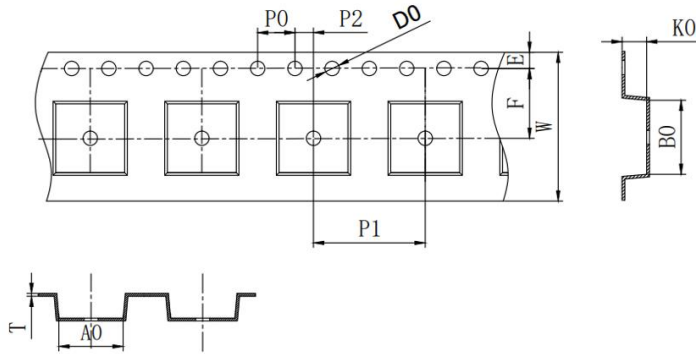

Fig.7-Current Derating

Carrier Tape & Reel Specification DFN8x8



SYMBOL	Millimeters	
	Min.	Max.
A0	8.30	8.50
B0	8.40	8.60
K0	1.20	1.40
P0	3.90	4.10
P1	11.90	12.10
P2	1.95	2.05
T	0.20	0.30
E	1.65	1.85
F	7.40	7.60
D0	1.50	1.60
D1	1.50	
W	15.70	16.30

Mechanical Dimensions DFN8x8

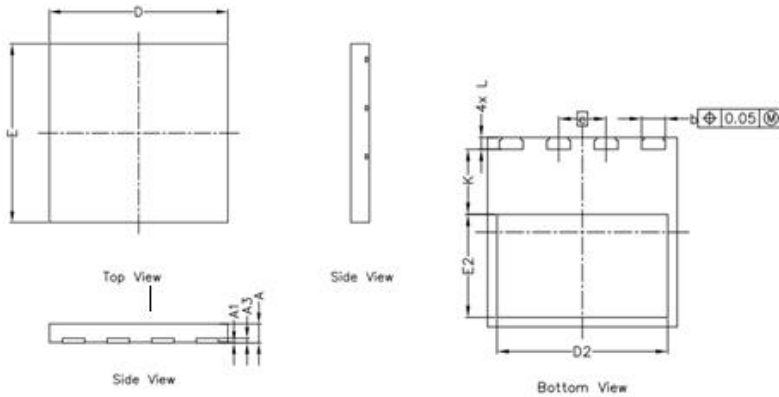

SYMBOL	Millimeters	
	Min.	Max.
A	0.800	0.900
A1	-	0.050
A3	0.195	0.211
D	7.900	8.100
E	7.900	8.100
e	2.00 BSC	
b	0.950	1.050
D2	7.100	7.300
E2	4.250	4.450
L	0.400	0.600
K	2.650	2.850



DISCLAIMER:

- 1- The information given herein, including the specifications and dimensions, is subject to change without prior notice to improve product characteristics. Before ordering, purchasers are advised to contact the SMC Diode Solutions sales department for the latest version of the datasheet(s).
- 2- In cases where extremely high reliability is required (such as use in nuclear power control, aerospace and aviation, traffic equipment, medical equipment, and safety equipment), safety should be ensured by using semiconductor devices that feature assured safety or by means of users' fail-safe precautions or other arrangement.
- 3- In no event shall SMC Diode Solutions be liable for any damages that may result from an accident or any other cause during operation of the user's units according to the datasheet(s). SMC Diode Solution assumes no responsibility for any intellectual property claims or any other problems that may result from applications of information, products or circuits described in the datasheets.
- 4- In no event shall SMC Diode Solutions be liable for any failure in a semiconductor device or any secondary damage resulting from use at a value exceeding the absolute maximum rating.
- 5- No license is granted by the datasheet(s) under any patents or other rights of any third party or SMC Diode Solutions.
- 6- The datasheet(s) may not be reproduced or duplicated, in any form, in whole or part, without the expressed written permission of SMC Diode Solutions.
- 7- The products (technologies) described in the datasheet(s) are not to be provided to any party whose purpose in their application will hinder maintenance of international peace and safety nor are they to be applied to that purpose by their direct purchasers or any third party. When exporting these products (technologies), the necessary procedures are to be taken in accordance with related laws and regulations.